

**Ermetika**<sup>®</sup>  
INSIDE WALLS

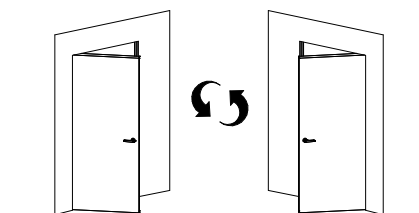
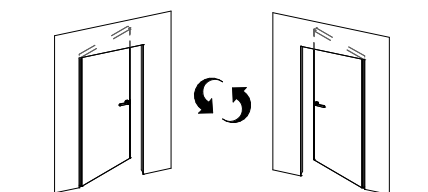
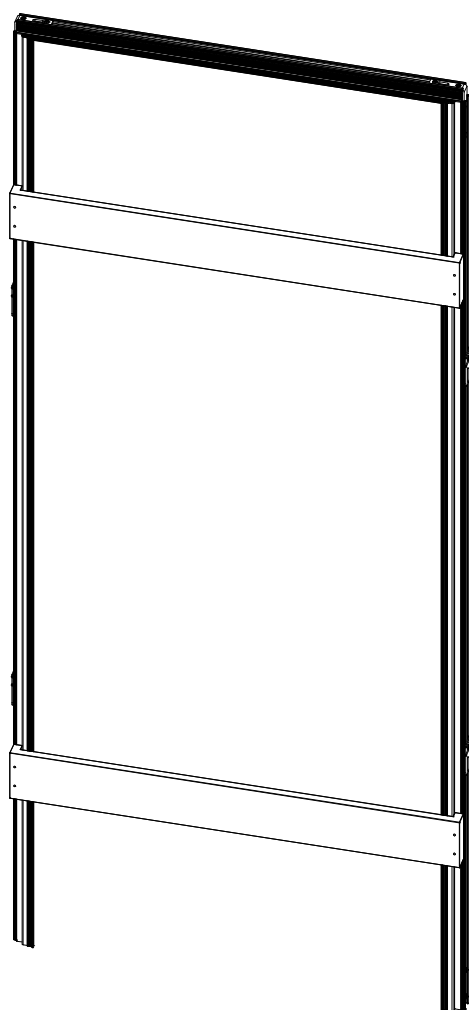

**ISTRUZIONE MONTAGGIO - SETUP INSTRUCTION  
INSTRUCTION MONTAGE- INSTRUCCIONES DE MONTAJE**

Absolute Swing Reverse

# CONTENUTO KIT | CONTENTS

Dotazione - Standard equipment - Equipement standard - Equipo standard

---

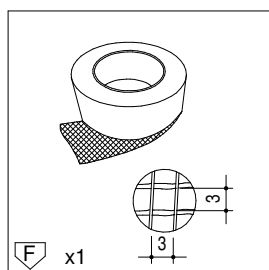
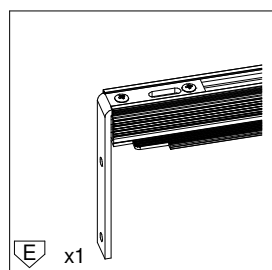
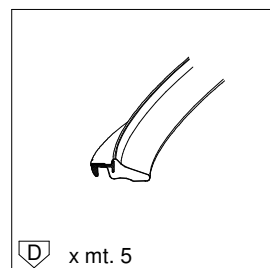
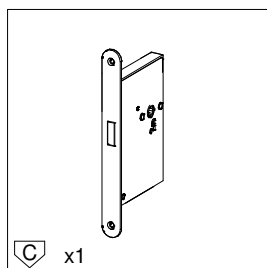
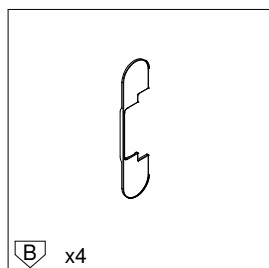
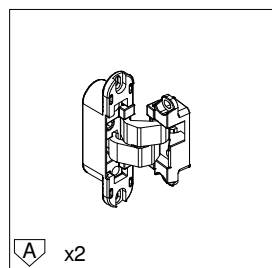

Attrezzatura - Tools - Outils - Herrajes

---

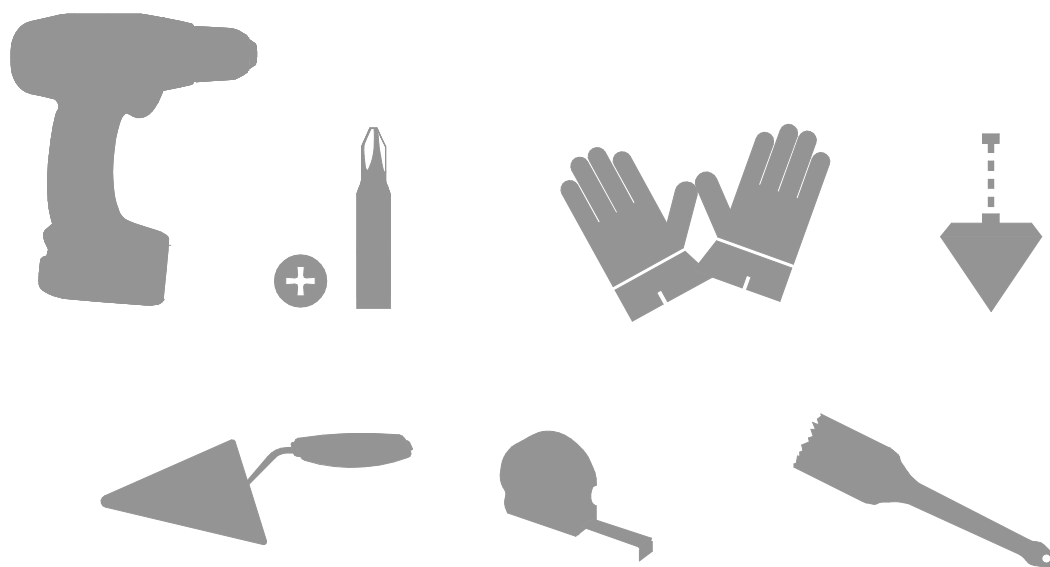

# CONTENUTO KIT | CONTENTS

Panoramica - Overall view - Vue d' ensemble - General

---

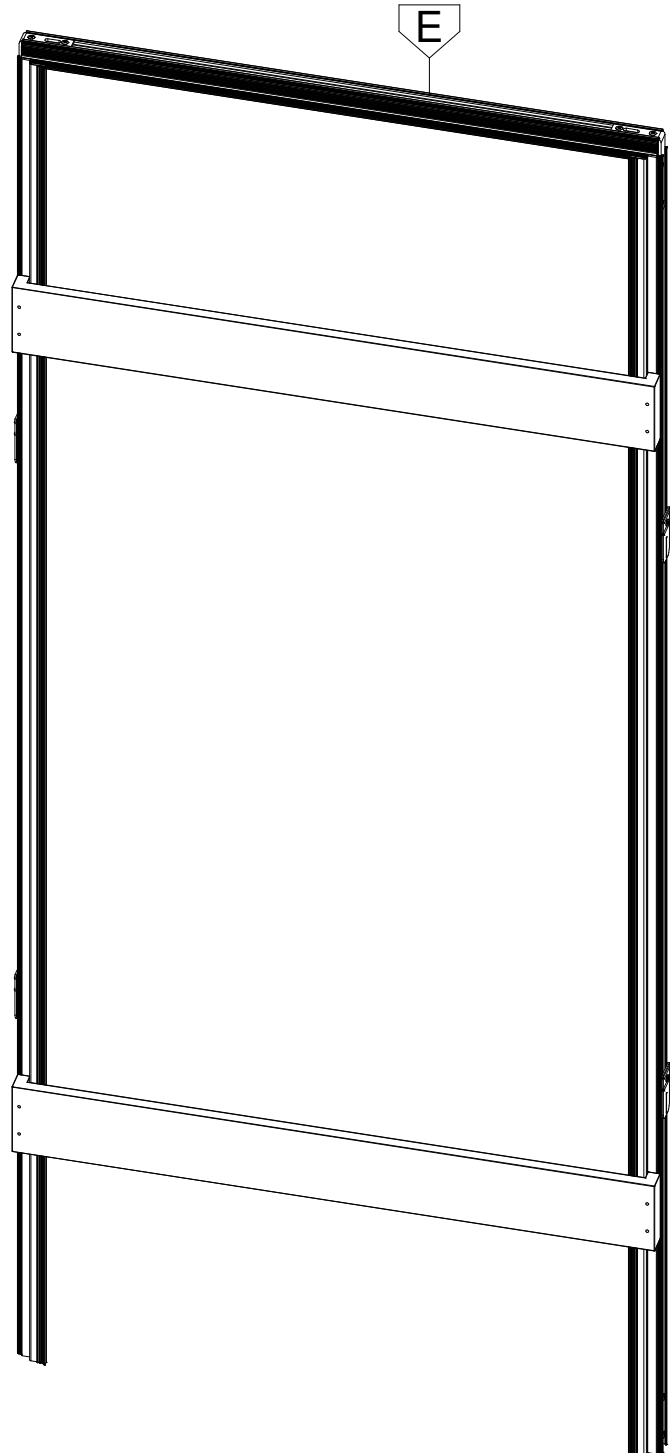

## INDICE - INDEX

---

Intonaco - Plaster	2-8
Cartongesso - Plasterboard	9-13

1.1

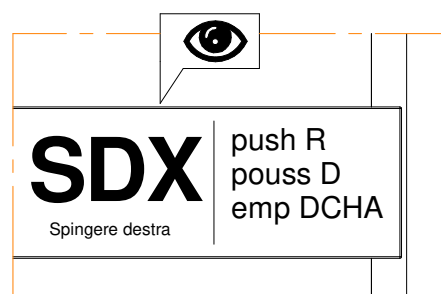
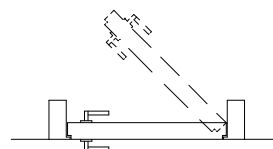
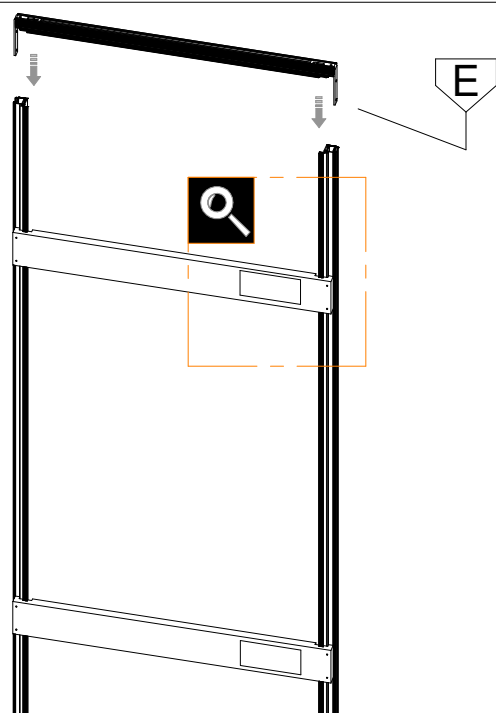

1.2

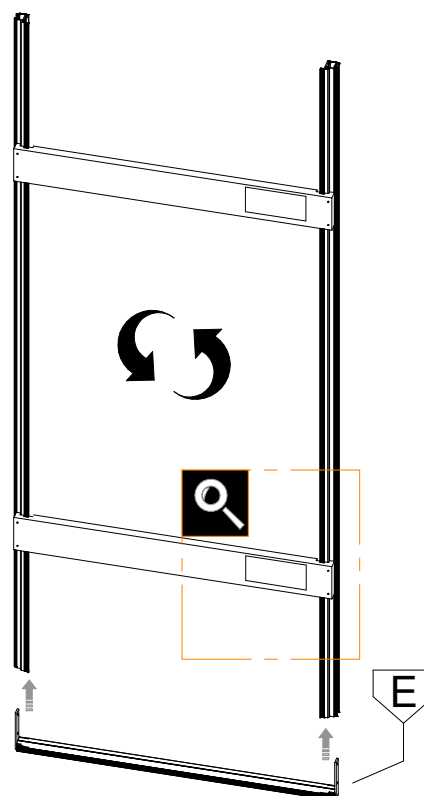
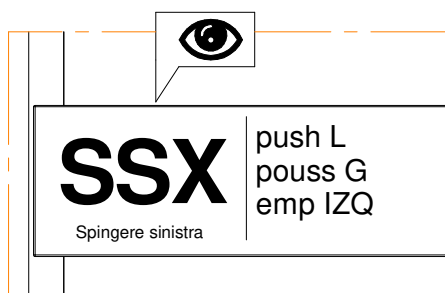
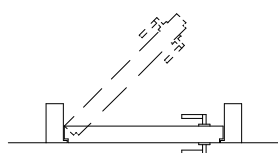

1.3

1.4

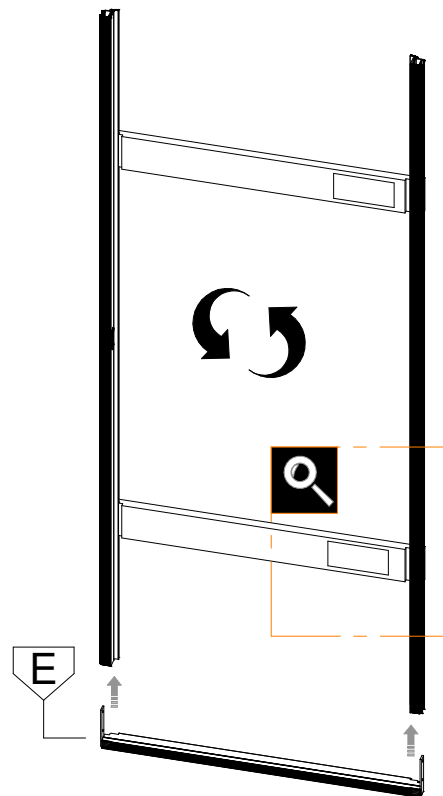
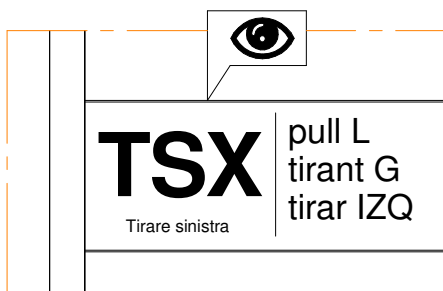
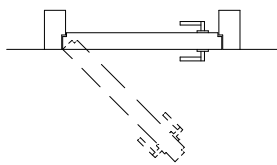
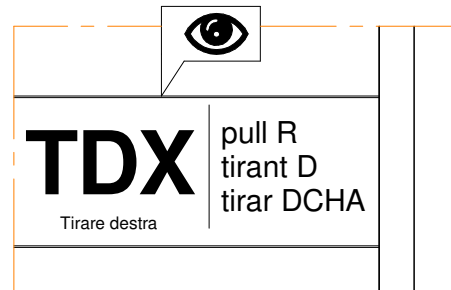
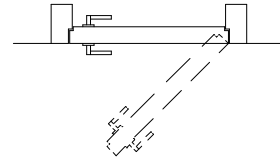
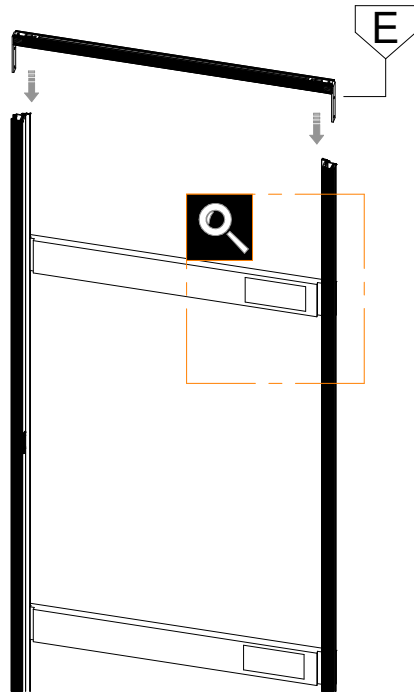

Subject to misprints, errors and technical modifications.  
All dimensione are in mm

1.5

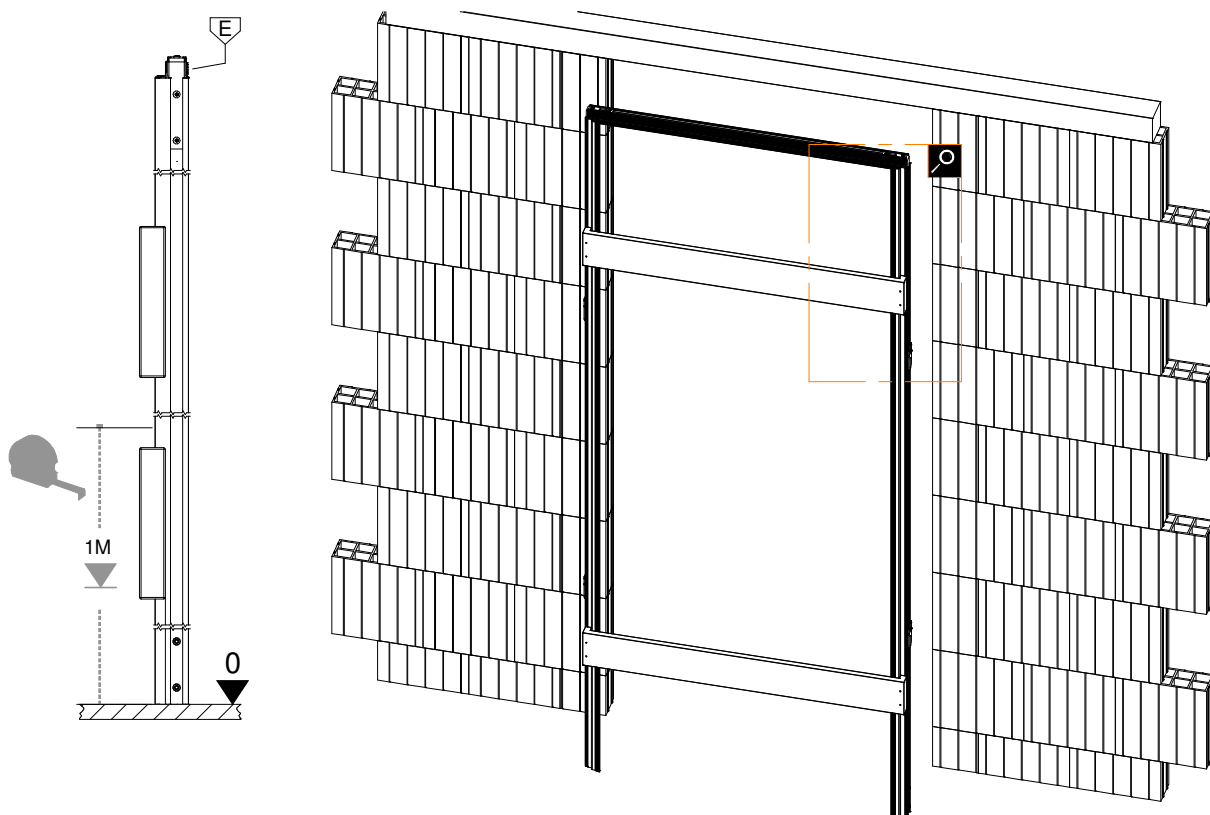

**SPINGERE - PUSH -  
POUSSANT - EMPUJAR**

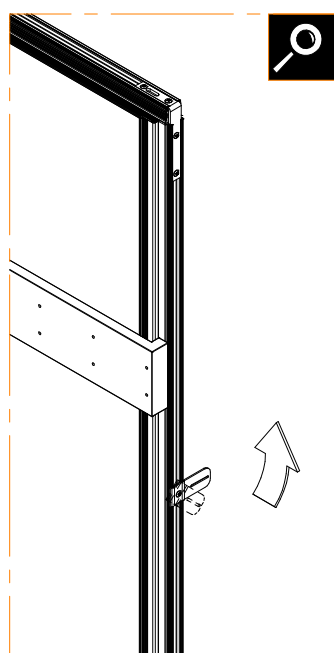

**TIRARE - PULL -  
TIRANT - TIRAR**

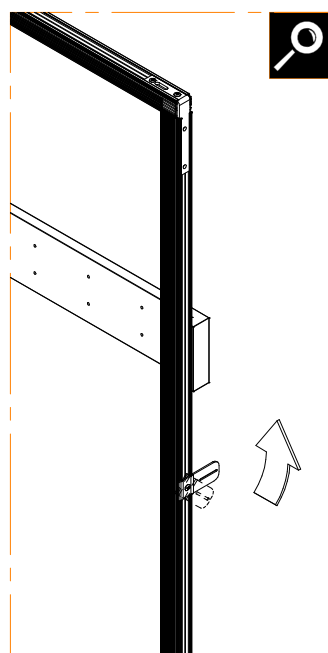

1.6

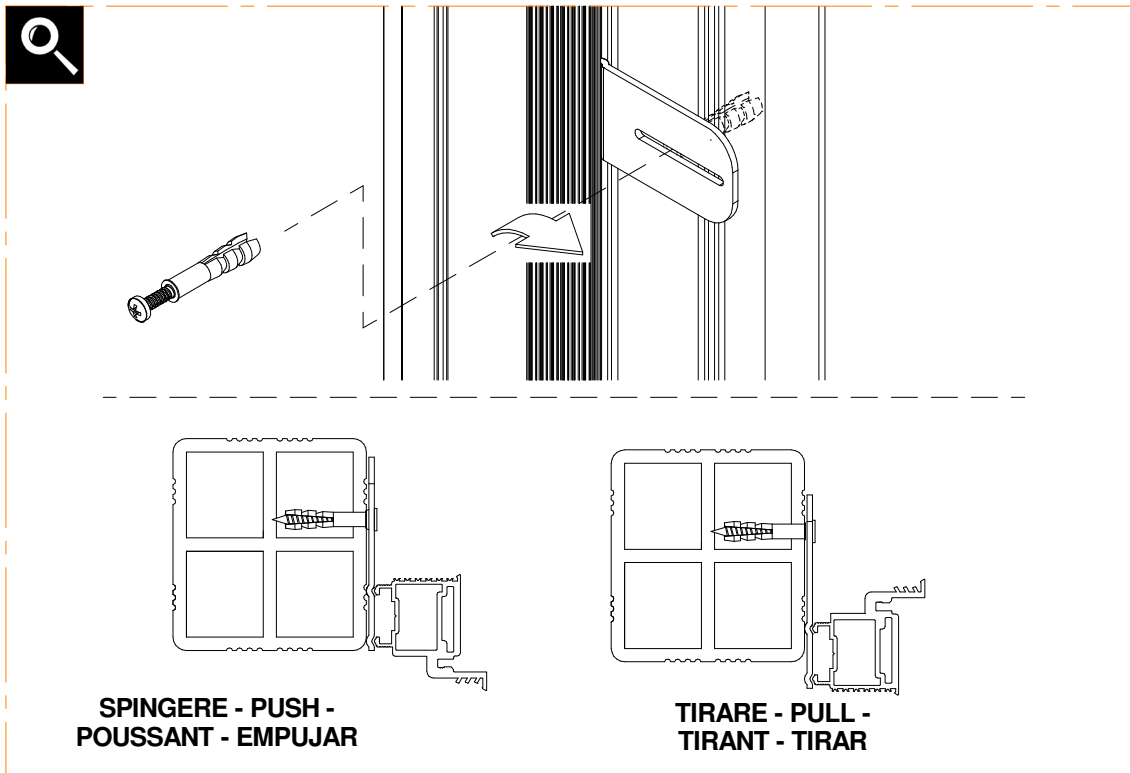
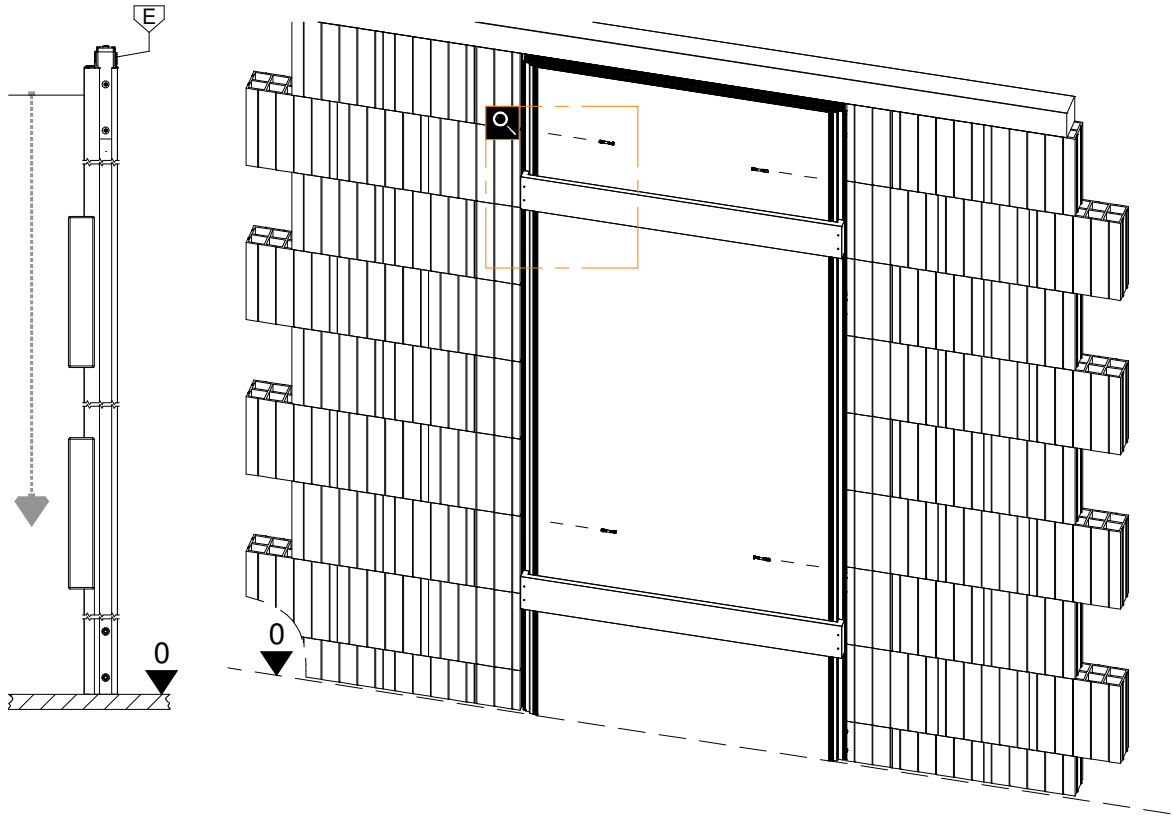

Subject to misprints, errors and technical modifications.  
All dimensione are in mm

1.7

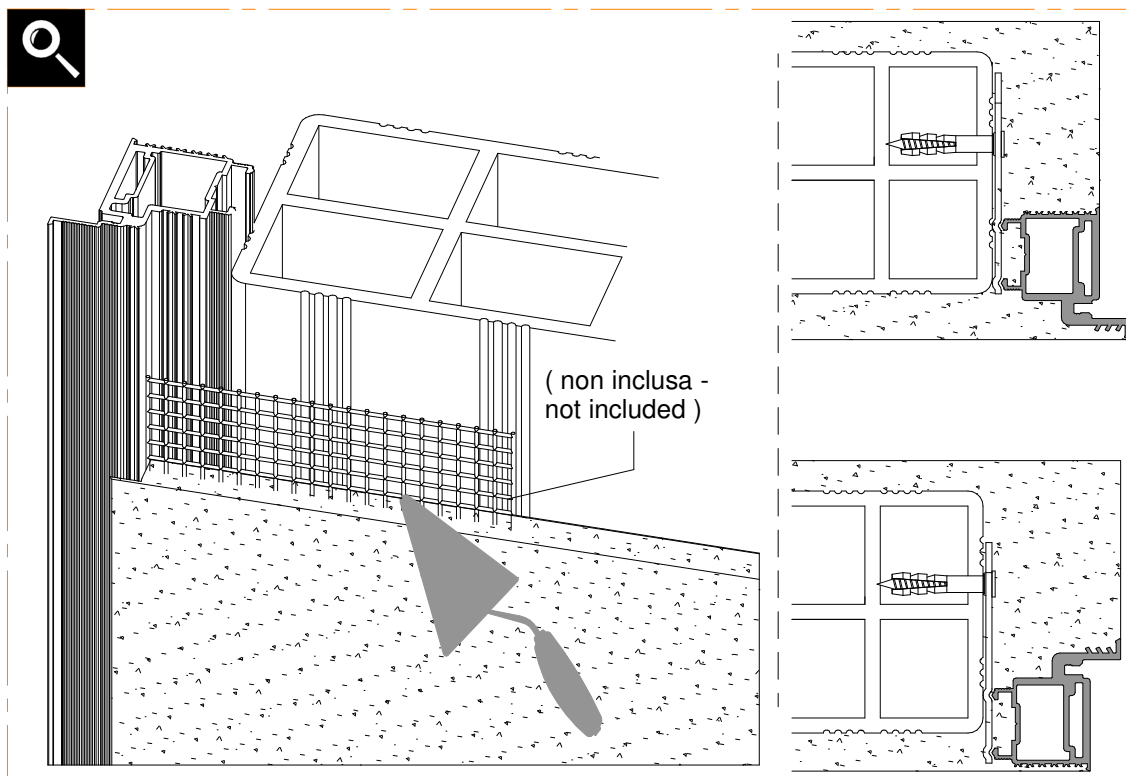
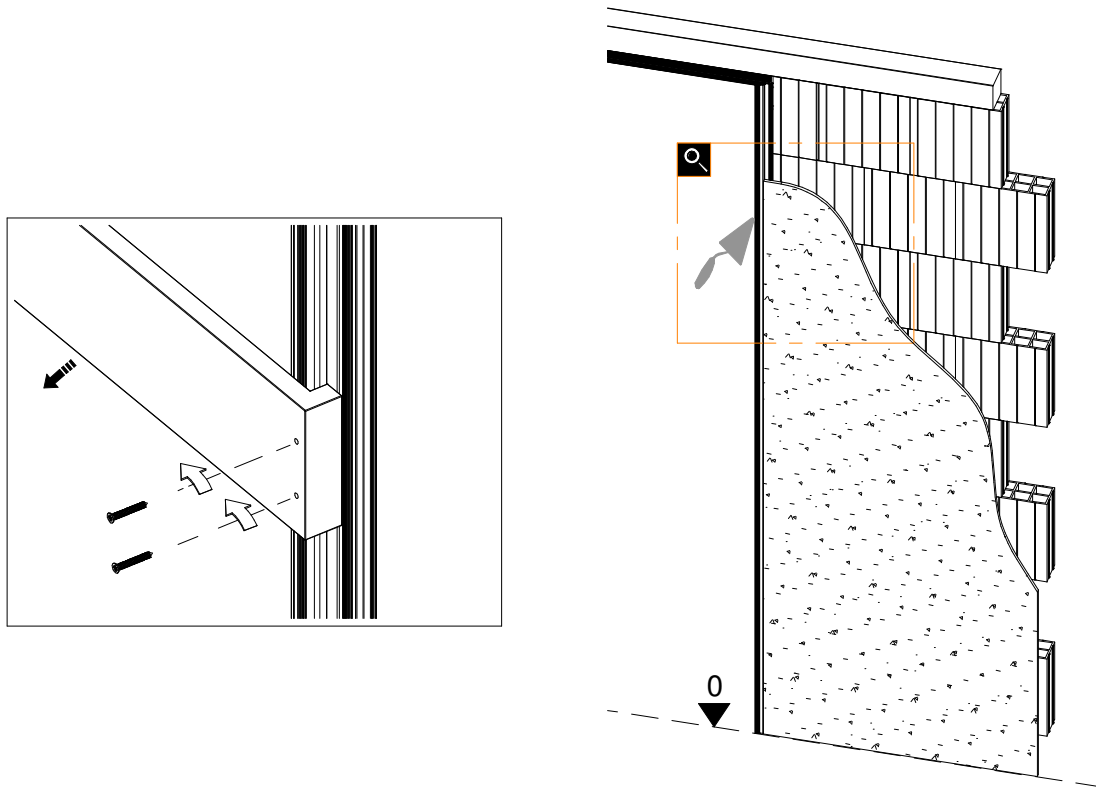



1.8

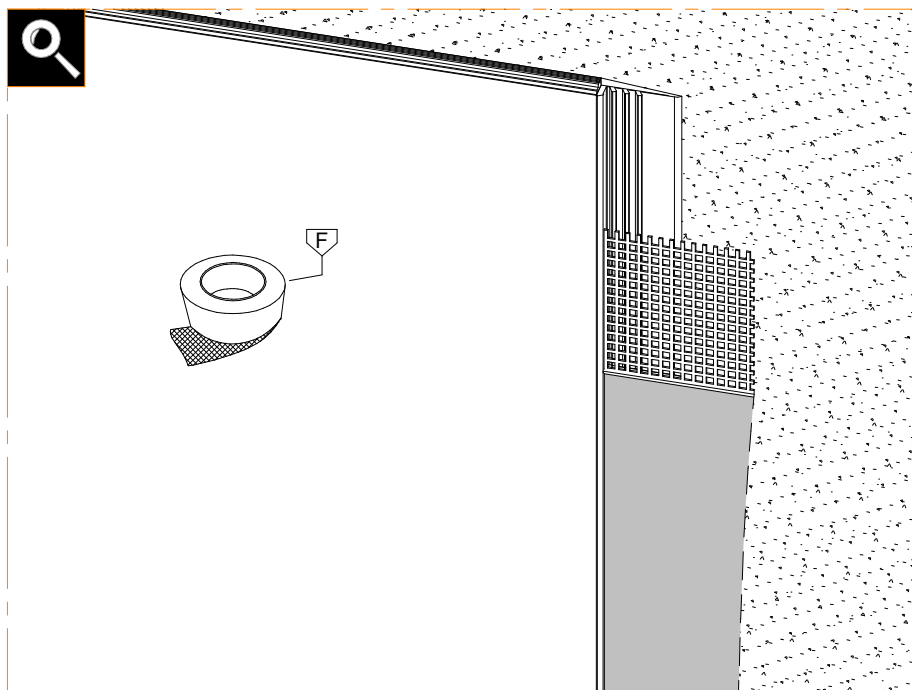
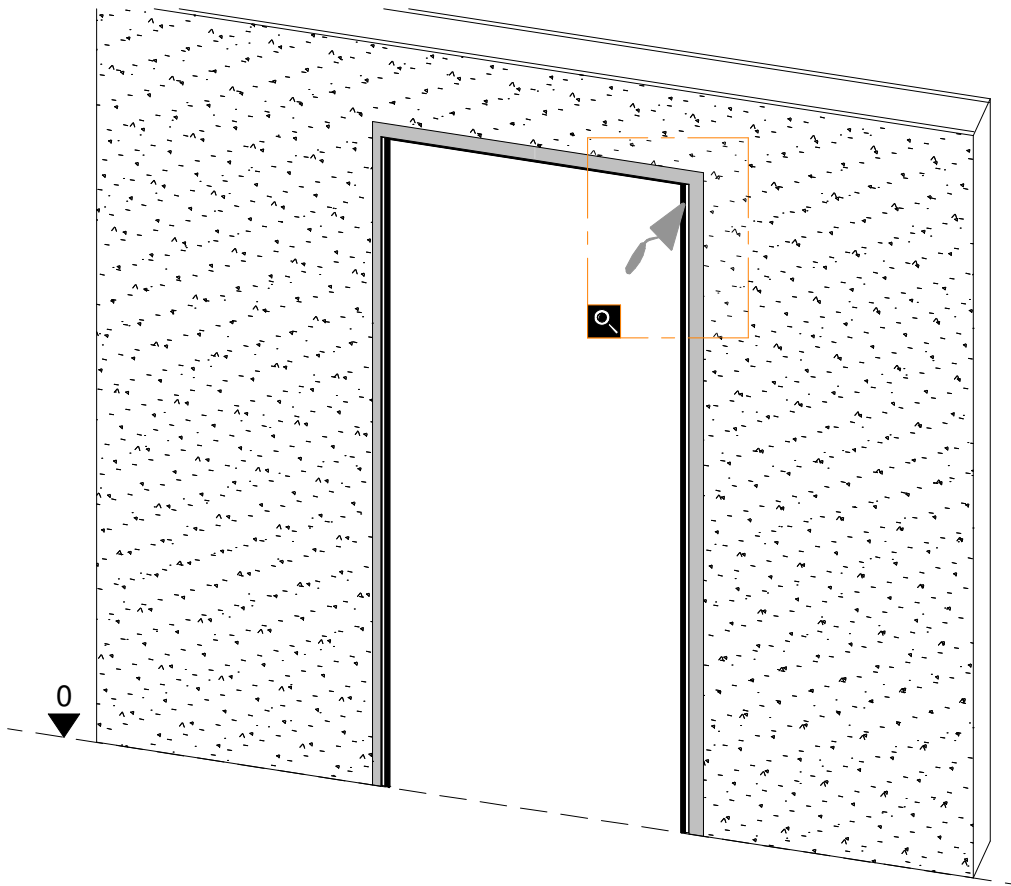

Subject to misprints, errors and technical modifications.  
All dimensione are in mm

2.1

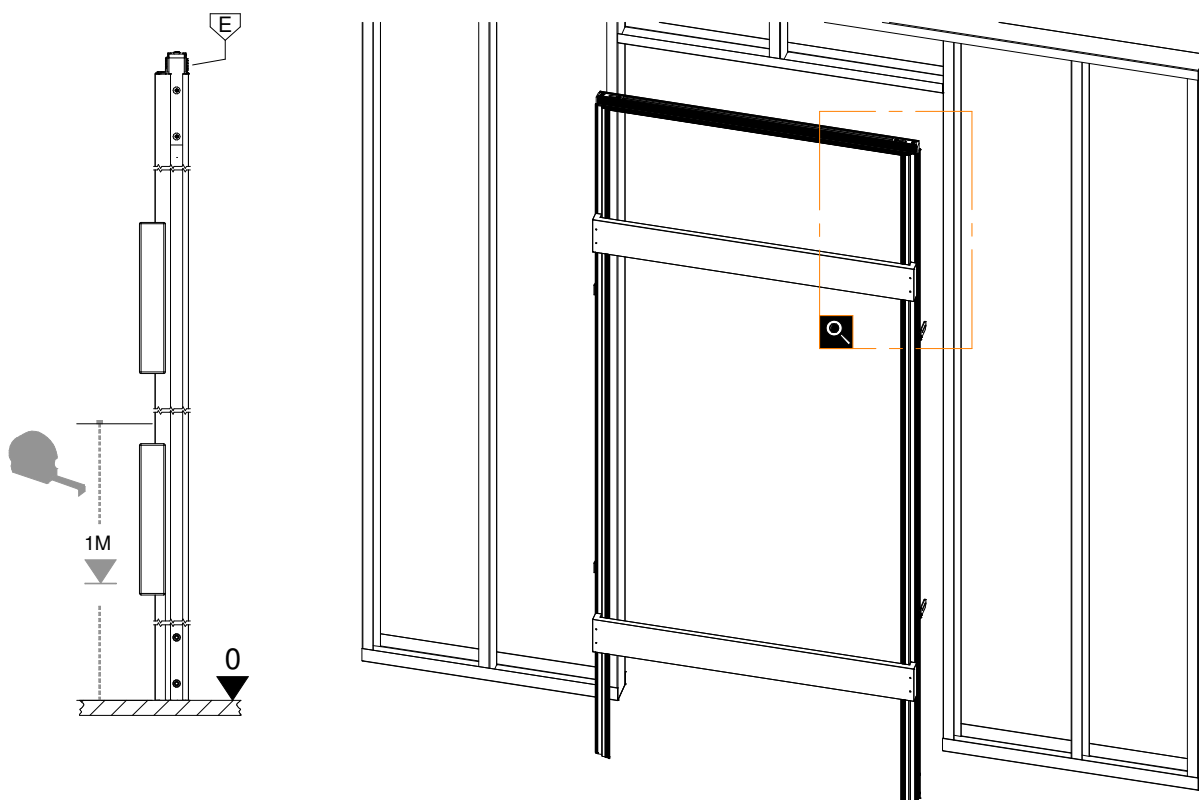

**SPINGERE - PUSH -  
POUSSANT - EMPUJAR**

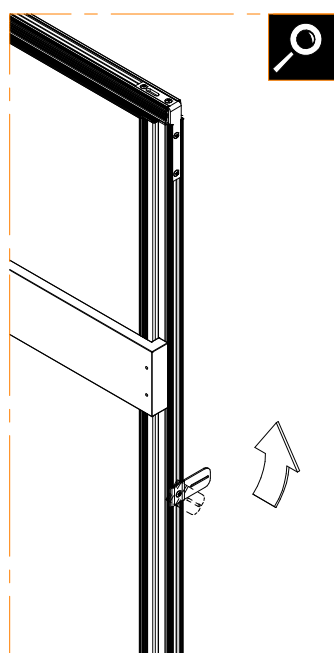

**TIRARE - PULL -  
TIRANT - TIRAR**

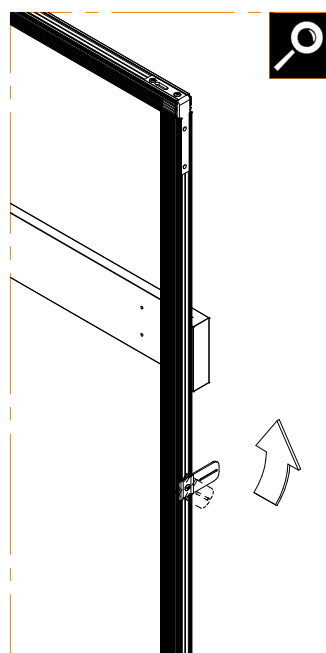

2.2

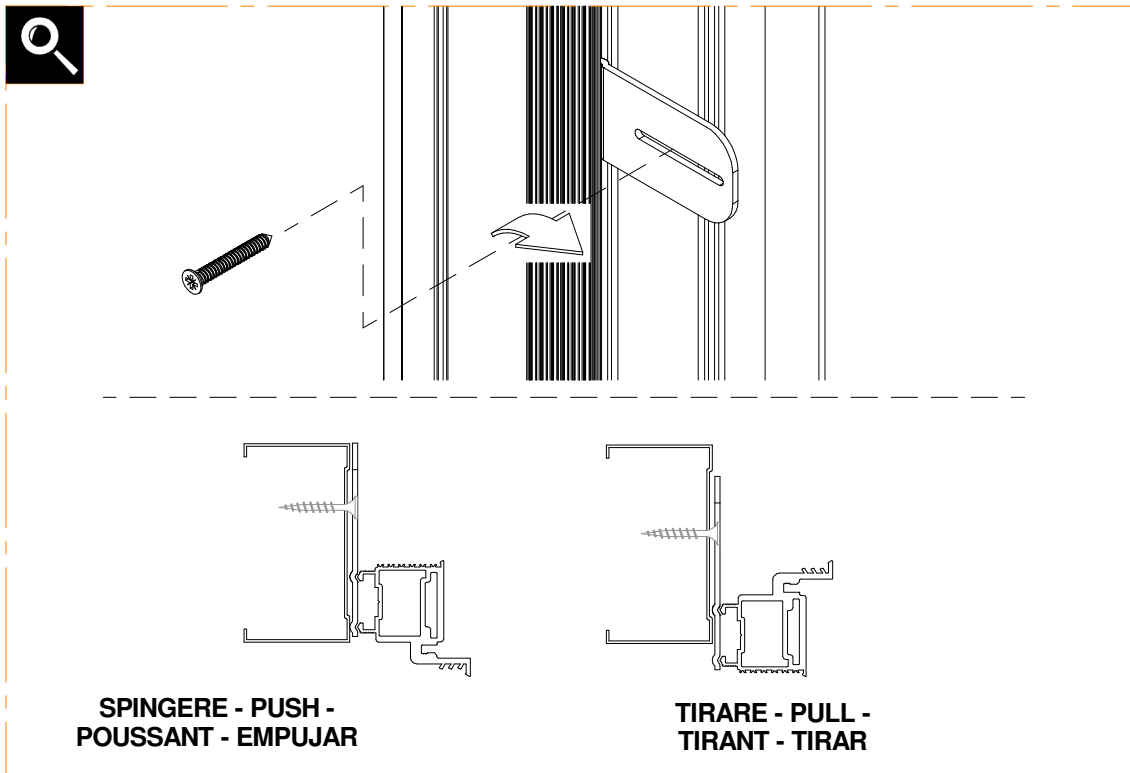
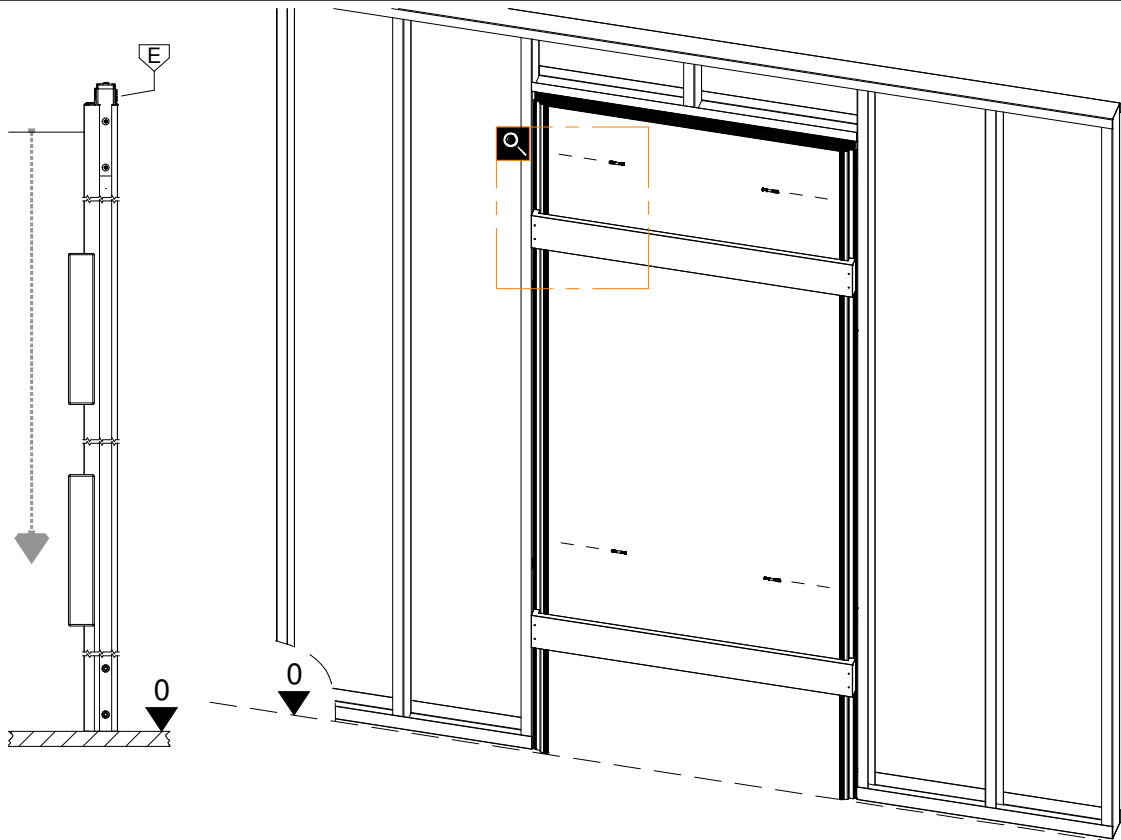

Subject to misprints, errors and technical modifications.  
All dimensione are in mm

2.3

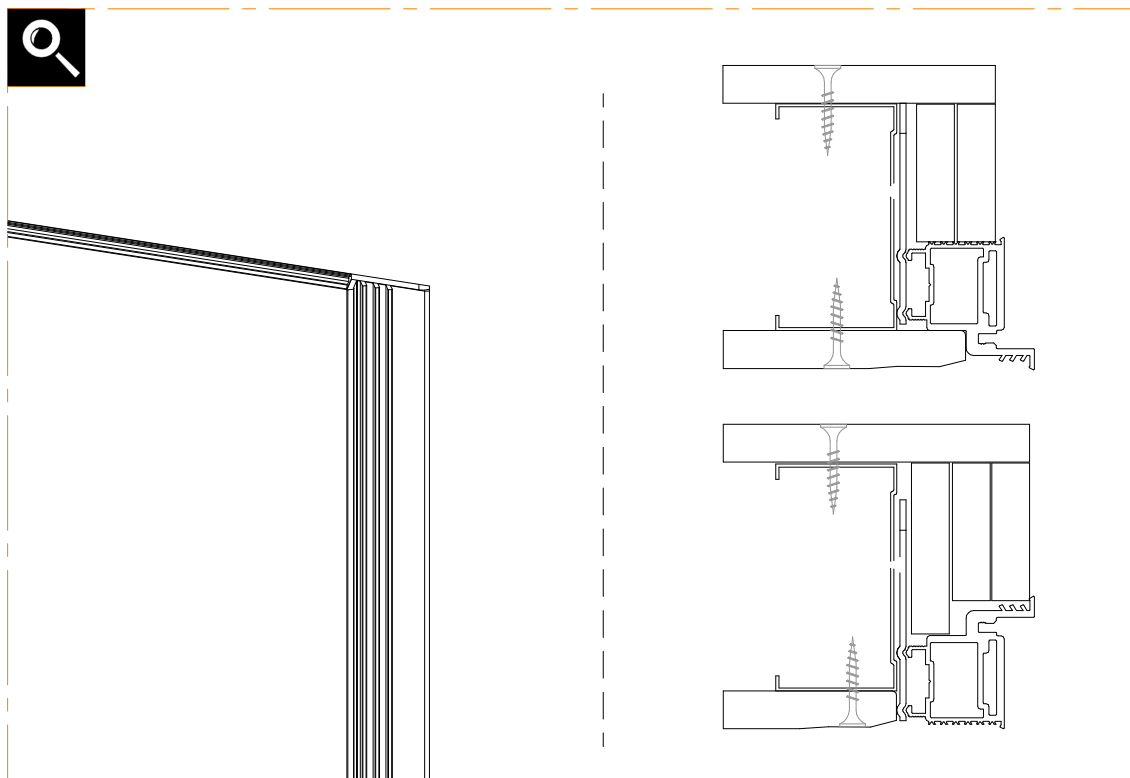
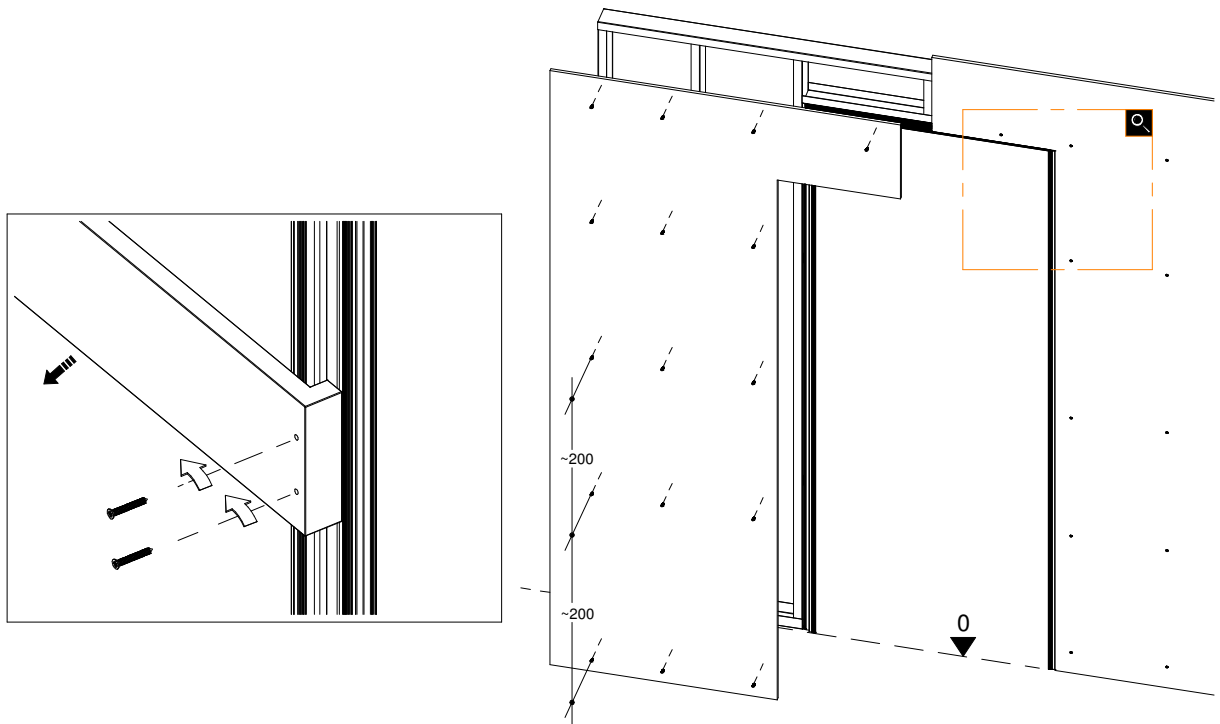

2.4

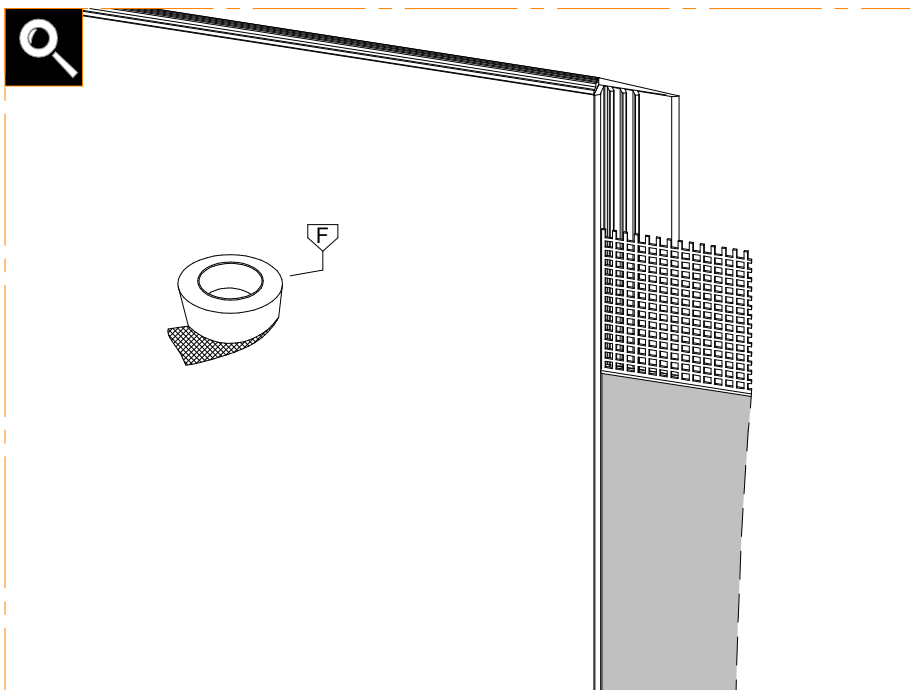
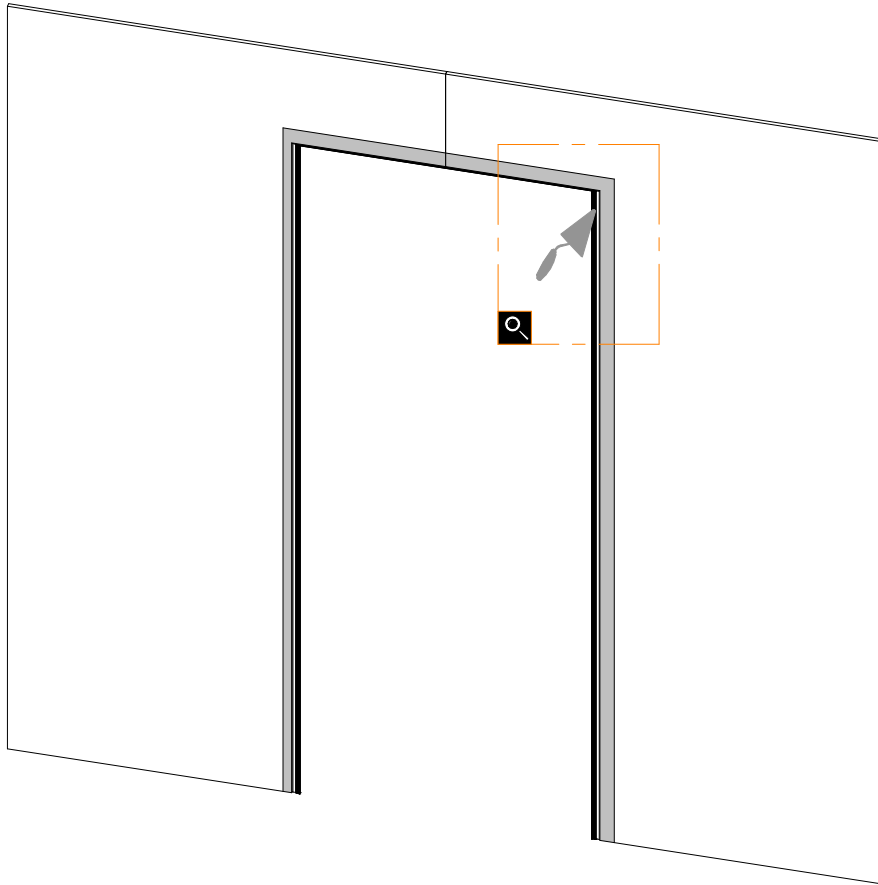

Subject to misprints, errors and technical modifications.  
All dimensione are in mm

2.5

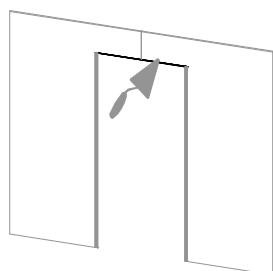

**SPINGERE - PUSH -  
POUSSANT - EMPUJAR**

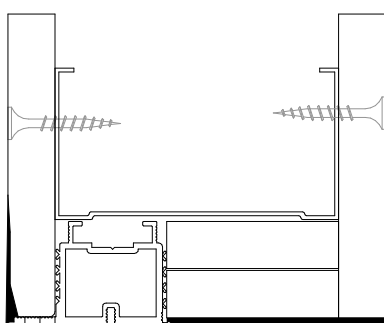

**TIRARE - PULL -  
TIRANT - TIRAR**

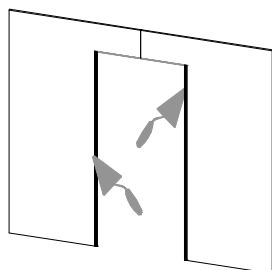
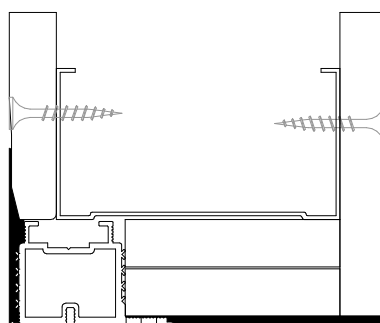

**SPINGERE - PUSH -  
POUSSANT - EMPUJAR**

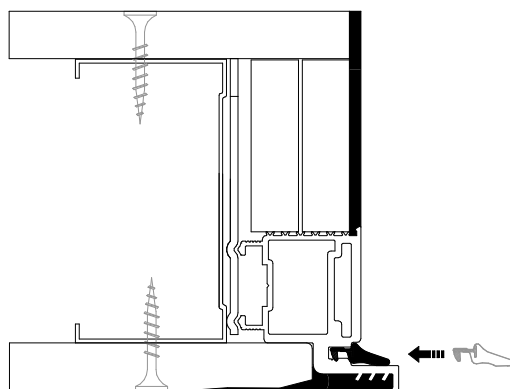

**TIRARE - PULL -  
TIRANT - TIRAR**

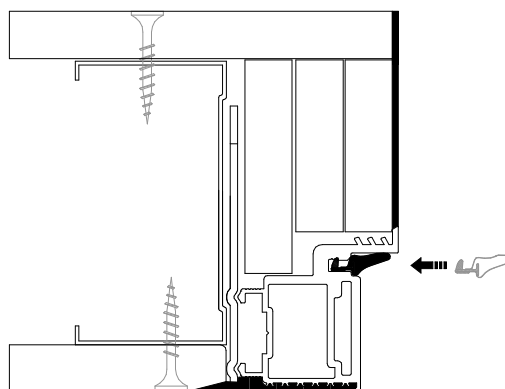

2.6

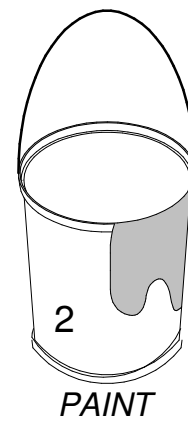
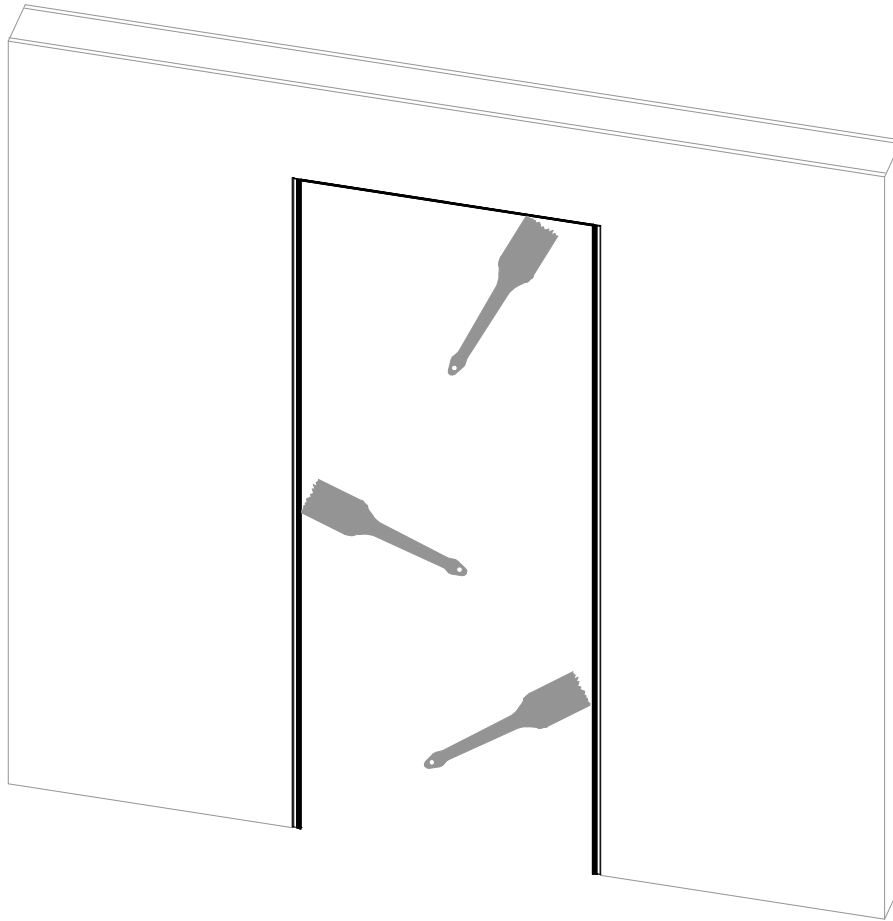



T. +39 (0)883535781



info@ermetika.it



www.ermetika.it



www.youtube/ermetika.it